

Article number: 2310305475ESD

Description: E+G Antistatic base for levelling elements
LV.A-100-14-M12x98-ESD-C

Measures

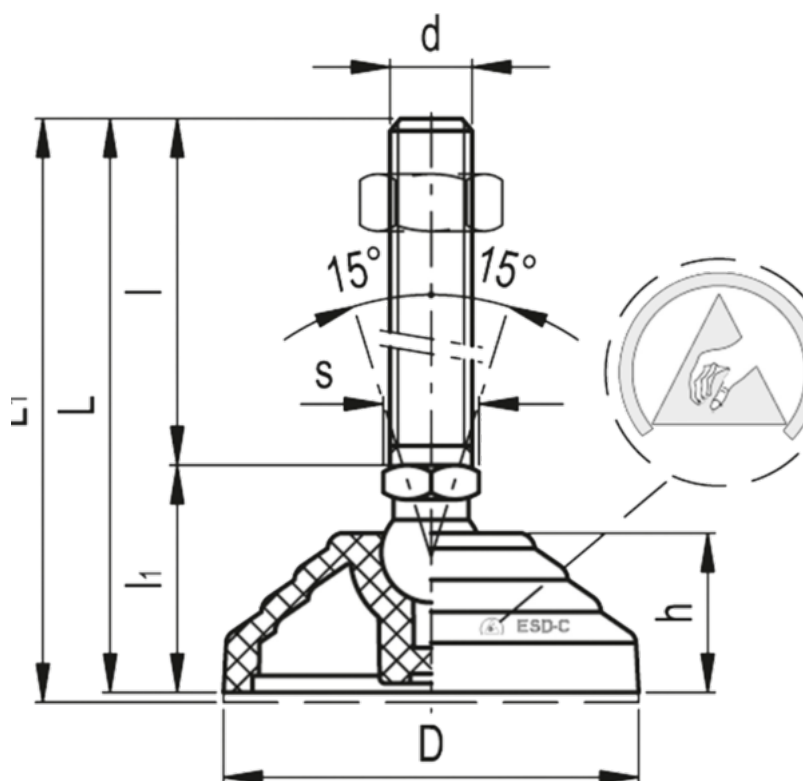

Articulation = 14
D = 100
d = M12
h = 24
l = -
l1 = -
L = 131
Max load = 18000

s = 14
Weight in (g) = 148